



Item No. : 502001B-24

Hardware

No.	Draw	Qty
A		2 PCS
B		2 PCS
C		2 PCS

Assembly Instructions

Step1

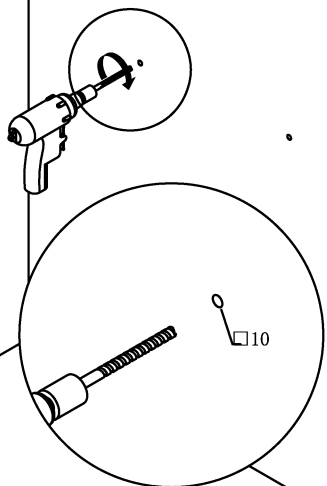

Step2

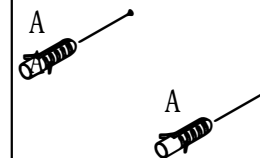

Step3

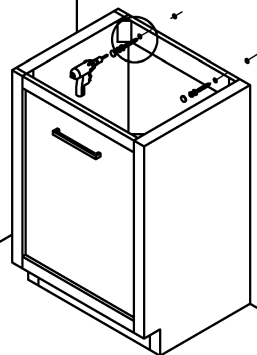
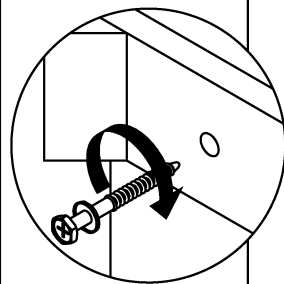

Step4

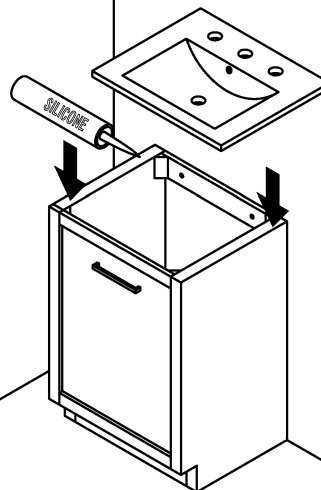

Finished

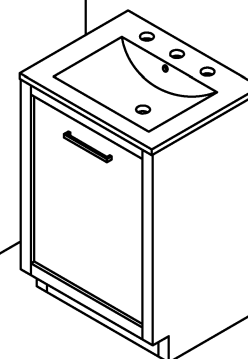

Description:
Main Cabinet
Size:
600x460x850mm

Tools:

